

# 132 Series Sliding Window

## Standard Size Range / Configurations

**Stud Opening** (Frame Size with reveals + 10mm clearance)

**Outer Frame Size** (excludes fixing fin & reveals)

|             |      | Width (mm) |     |      |      |      |      |      |      |
|-------------|------|------------|-----|------|------|------|------|------|------|
|             |      | 660        | 960 | 1260 | 1560 | 1860 | 2160 | 2460 | 2760 |
|             |      | 610        | 910 | 1210 | 1510 | 1810 | 2110 | 2410 | 2710 |
| Height (mm) | 650  |            |     |      |      |      |      |      |      |
|             | 950  |            |     |      |      |      |      |      |      |
| 1250        | 1200 |            |     |      |      |      |      |      |      |
|             | 1550 |            |     |      |      |      |      |      |      |

### Legend

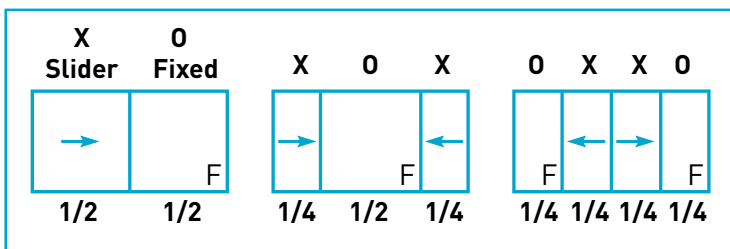

**Note: The above Size Range also applies to the 076 Series Double Glazed Sliding Window (XO & XOx configurations only available).**

### Product Specific Notes:

- Configurations greater than 2710mm wide are available.
- All configurations are viewed from the outside looking inside.
- All two panel windows will be supplied as XO (slider / fixed) unless requested otherwise.
- Key lock handle upgrade available (additional cost applies).

# 132 Series Window Wall

## Standard Size Range / Configurations

**Stud Opening** (Frame Size with reveals + 10mm clearance)

**Outer Frame Size** (excludes fixing fin & reveals)

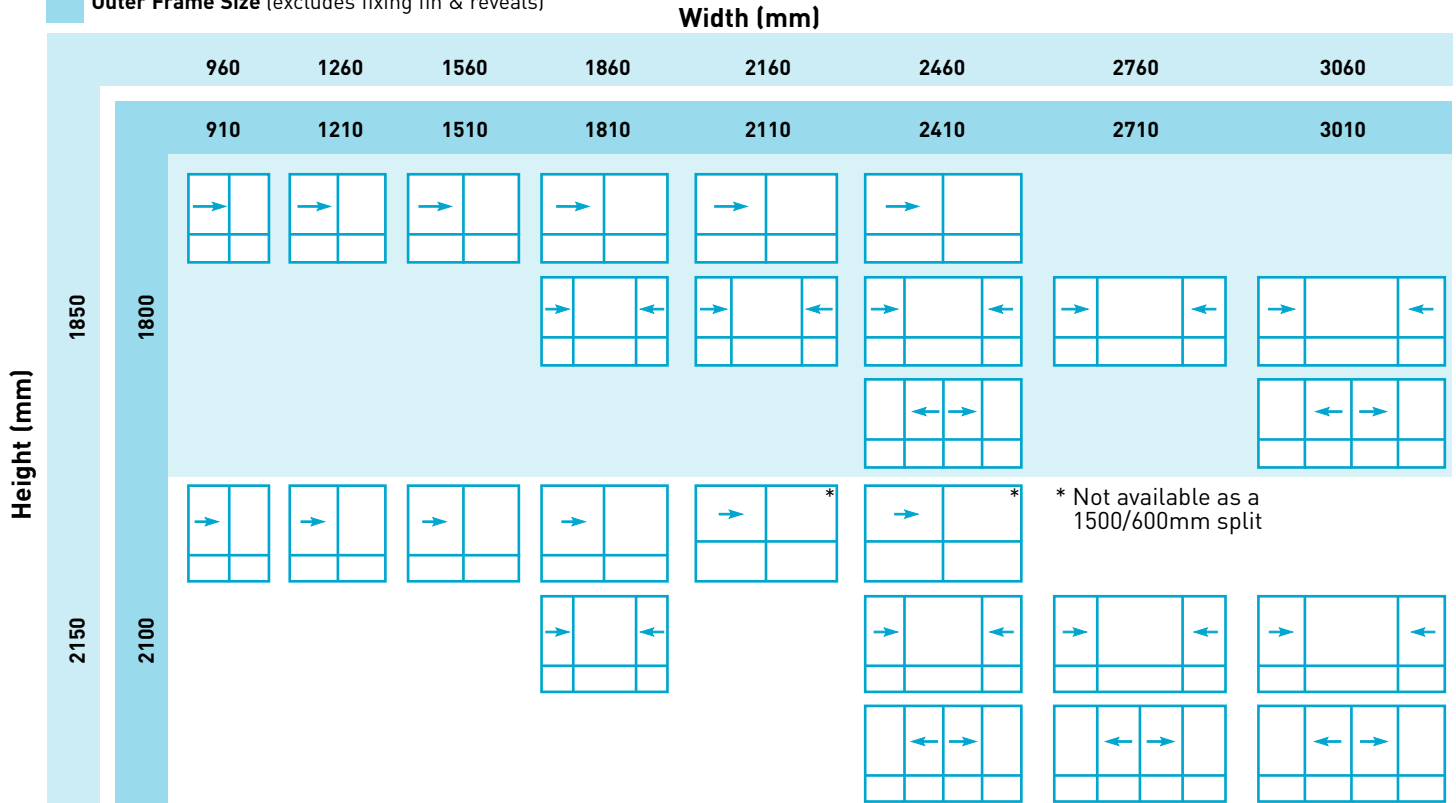

\* Not available as a 1500/600mm split

### Legend

#### 1800mm High Split

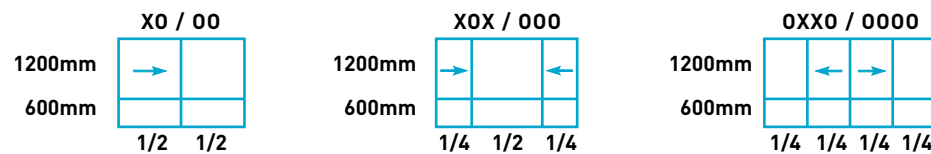

#### 2100mm High Split Options (Customer is to nominate the height split required at time of order).

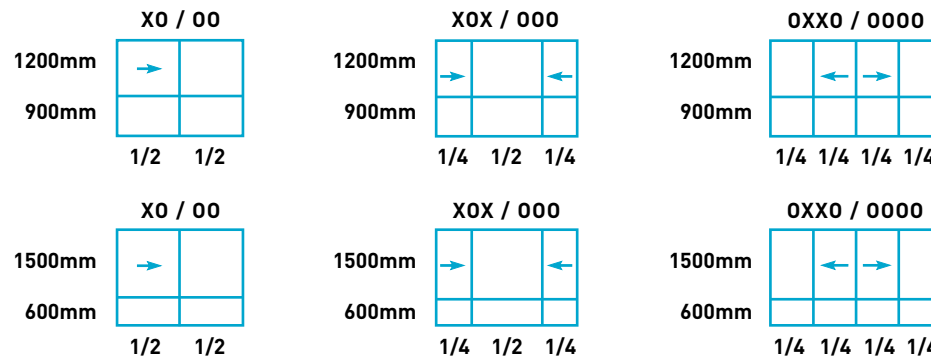

### Options

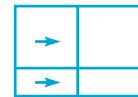

XO / XO Window Wall

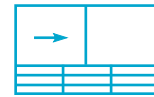

XO with 3 Bay Louvre Low Light



Window Wall with Semi-Circle Head

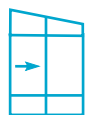

Window Wall with Raked Head

### Product Specific Notes:

- All configurations are viewed from the outside looking inside.
- All two panel windows will be supplied as XO (slider / fixed) unless requested otherwise.
- The above '2100mm high' illustrations are scaled with a 1500/600 transom split with the exception of 2110mm & 2410mm wide units

- which are only available with a 1200/900mm split.
- Mullion(s) to bottom fixed panels will be supplied as standard unless otherwise requested.
- All panels to the lower portion of a window wall will be supplied as fixed panels unless requested otherwise.
- Height splits refer to the centre of the transom.
- Key lock handle upgrade available (additional cost applies).