

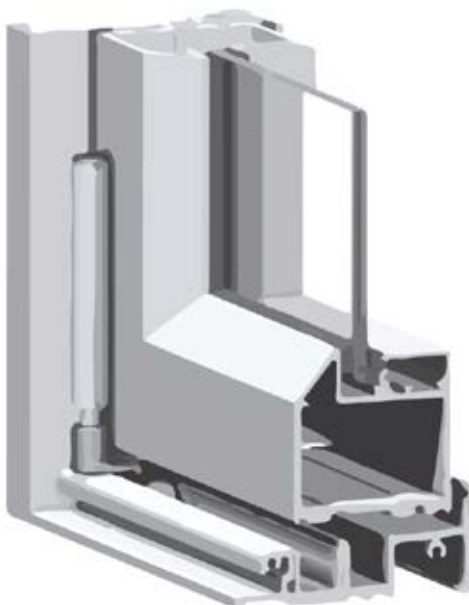

G.JAMES
Windows & Doors

Bi-fold Door 477 Series



Experience the true meaning of open living when you select a G.James 477 Series Bi-fold Door.

The trademark 'fold-and-stack' function of bi-fold doors place them at the top of the shopping list for alfresco entertainment areas or any aspect where you want to optimise your view and opening space.

G.James' bi-fold doors combine quality hardware componentry with the uncompromising strength of heavy duty aluminium profiles to ensure you enjoy consistent, long-term performance along with the ultimate sensation of bringing the outdoors, indoors. Matching bi-fold windows are also available for a side-by-side combination units¹.

¹ Bi-fold Door/Window combinations are suitable for sheltered, non-exposed positions only. **Left image:** Cut-through of Bi-fold door sill (guide only, subject to change without notice)



Features

- Precision ball bearing roller / guide system for smooth operation and an extended service life
- Multi-point locks provide excellent security along with easy, single-action locking/unlocking
- 'Top hung' or 'bottom rolling' systems available¹
- Internally fitted, retractable flyscreen option available
- Choice of configurations including the option for a service leaf.
- 7 year 'peace of mind' guarantee
(Terms and conditions apply)
- Full perimeter, continuous weather seals bring exceptional weatherproofing and acoustic performance

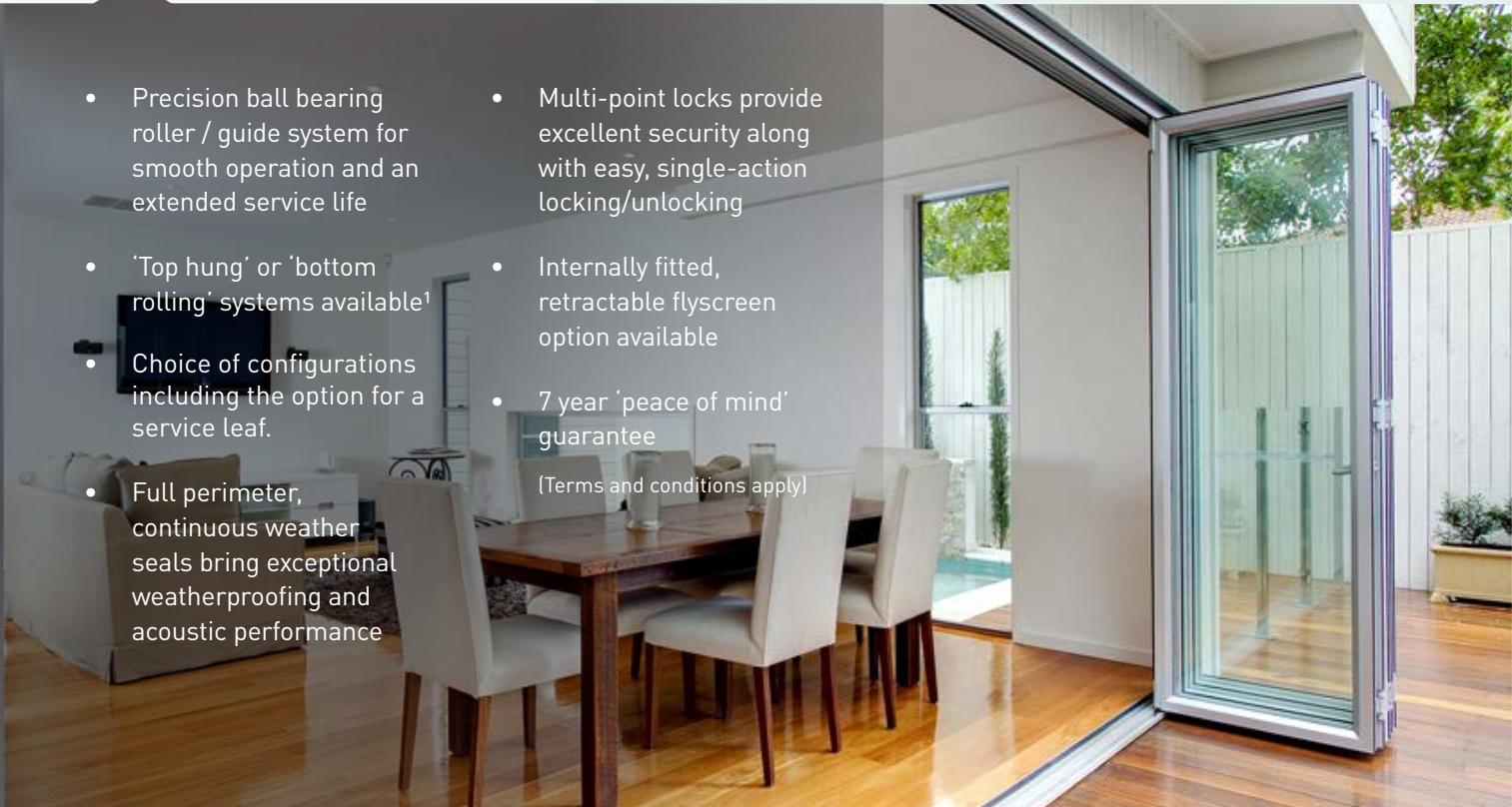

Technical Data

¹ Structural beam by builder required for all top-hung systems

Size Limitations¹

Refer the Configurations section of this brochure for size limitations

Other Limitations

This product is suitable for sheltered, non-exposed positions only

Max. Glass Thickness

- Single glazed – 10.38mm
- Double glazed (IGU) – 32mm

Max. Water Performance

- Standard sill - 150 Pa
- Sub-sill configuration - 600 Pa

Perimeter Frame Width

100mm

Screening

Retractable flyscreen systems only

WERS Data²

- U-Value range: 3.30 – 6.10
- SHGC range: 0.29 – 0.65

Acoustics²

Up to Rw 31

Bushfire Attack Level

G.James adopts the 'Deemed to Satisfy' approach for this product

Compatible Construction Types:

Brick veneer, clad wall, block wall and cavity brick

¹ Maximum sizes are a guide only and subject to the wind rating or SLS/ULS requirements of the site.

² Consult your G.James representative to determine the most suitable product configuration for your requirements.



Colour Selector

LEGEND: (C) COLOURBOND® Steel Colour Match
(G) Gloss (M) Matt (S) Satin

Powdercoat Colours



Black (S)



Monument (M)(C)



Woodland Grey (S)(C)



Ironstone (S)(C)

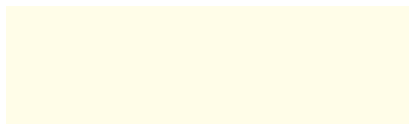

White Birch (G)

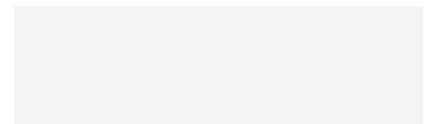

Architectural White (S)

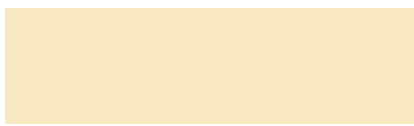

Primrose (G)



Paperbark (S)(C)



Pearl White (G)



Dune (S)(C)



Shale Grey (S)(C)

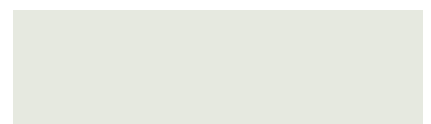

Surfmist (M)(C)



Ultra Silver (G)



Silver Pearl Kinetic® (S)
(Price on application)

Anodised Finishes



Clear



Residential Bronze

Note: All Anodised Finishes are price on application. All residential anodised finishes are supplied at AA15 (film thickness) with AA20 & AA25 available upon request. Polished Silver (internal products only) and other Bronze finishes are available – contact your G. James representative for further information.



Configurations

3 Leaf

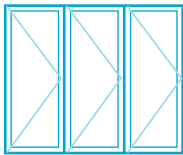

4 Leaf

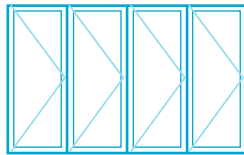

5 Leaf

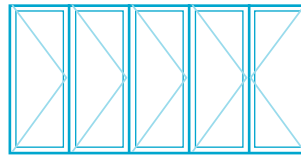

6 Leaf

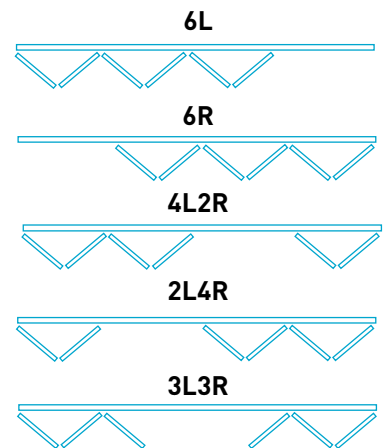
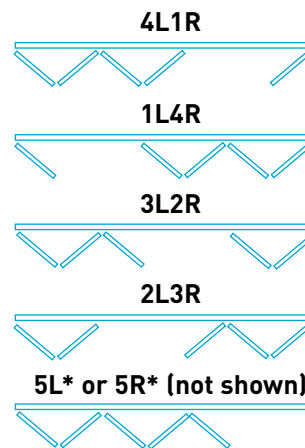
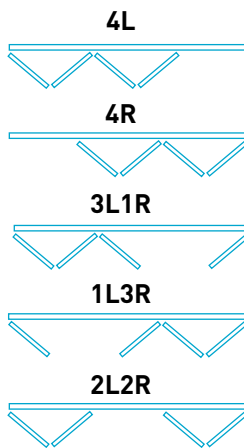
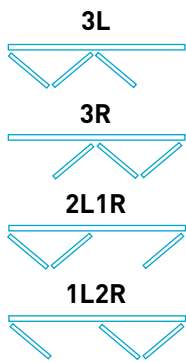
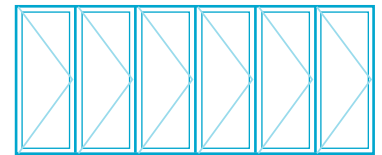

* Available with the 477-220 Series **Top Hung** Bi-fold Door only.

Product	Max. Height (mm)	Min. Width per Leaf (mm)	Max. Width per Leaf (mm)	Other
477-220 Series 'Top Hung' Bi-fold Door (Note: Structural beam (by builder) required for this product. See also first note below).	3000	700	<ul style="list-style-type: none"> > All 3L, 3R, 5L & 5R configs – 950mm > All other configs – 1000mm 	<ul style="list-style-type: none"> > Max. panel weight – 40 kg.
477-520 Series 'Bottom Rolling' Bi-fold Door	2550 (Max. height is dependent on leaf width)	450	<ul style="list-style-type: none"> > All 3L & 3R configs – 900mm > All other configs – 1000mm 	<ul style="list-style-type: none"> > Max. panel weight – 80 kg. > 5L & 5R configs are not available in the 477-520 Series.

Product Specific Notes:

- A structural overhead beam is required for 477-220 Series Top Hung Bi-fold Doors. All beams are to be supplied by the builder and engineered with a maximum 3mm sag when subjected to live and dead loads.
- Bi-fold Door / Window combinations are also possible however these

- units are suitable for sheltered, non-exposed positions only.
- Consult your G.James representative regarding configurations greater than 5 leaves to determine the most suitable configuration for your situation.
- Internal flyscreen option only, see you G.James representative for further informations.